

IOT BASED SMART ENERGY METER

Mr.G.Krishna Reddy
Associate Professor
ETE department, GNITS
Hyderabad,India

B.Ananya Sree
B.Tech,GNITS
ETE Department
Hyderabad,India

P.SriNidhi
B.Tech,GNITS
ETE Department
Hyderabad,India

S.Shivani
B.Tech,GNITS
ETE Department
Hyderabad,India

K.Rashmika
B.Tech,GNITS
ETE Department
Hyderabad,India

ABSTRACT:

An electronic gadget named, which is connected on the Internet of Things [8] is used to measure and track how much energy is used in a building or at home. By giving real-time feedback on energy use, it aids in lowering energy consumption. Additionally, it assists in identifying irregularities in energy consumption and gives the user a prompt warning. For remote data collection and analysis, smart energy meters are frequently connected to the internet.[1] Both a current sensor and a voltage sensor are employed in this circuitry, allowing for the measurement of both current and voltage as well as the generation of power consumption and total power spent (in units). Energy meter and power data are still analyzed monthly for billing purposes. Billing does indicate. [2]

Keywords: Energy meter, Internet of Things, current sensor, voltage sensor

1. INTRODUCTION

An IOT (Internet of things) based energy meter is a device that detects and analyzes the amount of electricity utilized by a building or residence and transmits this information to a central server using IOT technology.[14] Traditional energy meters only offer periodic Readings, which makes it challenging to spot areas with excessive energy use and promotes inefficient energy use. This issue is solved by IOT-based energy meters, which offer real-time monitoring of energy consumption. [3] This technology makes it possible for consumers to keep an eye on and manage their energy use, which saves money and lowers the overall carbon footprint of energy use. As they offer more ease and flexibility for usage, IOT-based energy meters are becoming more and more common in homes and businesses. Devices used in daily life can be connected with IOT. Several tools are available for monitoring and remotely controlling IOT-connected devices. The IOT idea offers fundamental organization and opportunities to connect the physical world to computer-based systems. For many wireless devices, which are expanding quickly on the market, the idea is crucial. It utilizes the Internet to link hardware devices to one the server. [4]

2. METHODOLOGY

The goal is to develop a smart energy meter which uses internet of things. This system requires components such as a current sensor, transistor, LCD, load, relay module, Wi-Fi module .The

steps in methodology are as follows:

1. Configuring the Wi-Fi module board with the required libraries and software to control the relay, current sensor, and transistor modules.
2. Creating a wireless communication channel with a server (Project factory) by connecting the Wi-Fi module to the Internet server.
3. To gather data from the load, connect the transistor and current sensor to the Wi-Fi module.
4. Checking the load levels by programming the Wi-Fi module board
5. Testing and assessing the system's functionality performance.

Energy consumption data is collected and transmitted to a central server using sensors and communication technology in the methodology for IOT-based energy meters. In order to pinpoint locations with excessive energy consumption and offer suggestions for how to optimize power consumed [11], this data is then examined. To further maximize energy economy, the device can be connected. This endeavor bridges a communication gap between consumers and energy utilities, allowing them to communicate more effectively and adopt two conservation strategies. [6]Consumers must be given a better grasp of the meter in order to correct misconceptions. A case study is conducted using typical data acquired from sixteen groups of households. [2]

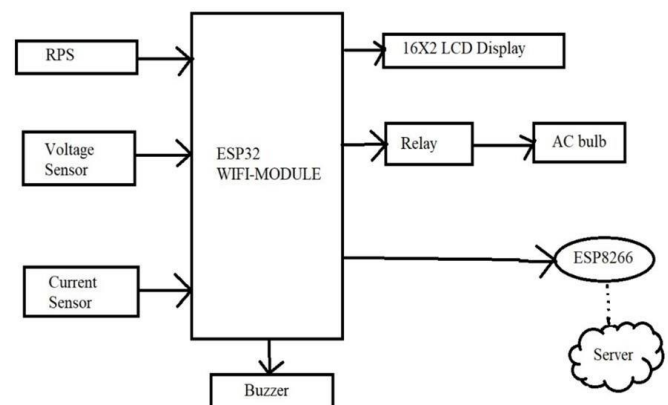

Fig 2.1 Block diagram

3. HARDWARE COMPONENTS:

A tool used to gauge the alternating current (AC) flowing through a single-phase electrical circuit is the ZHT102 5A Single Phase AC Current Sensor Module. It offers a secure, non-intrusive way to check the current levels without breaking the circuit or establishing direct electrical contacts. This module has a measurement range of 0 to 5 Amperes for AC currents.[7]

The data pertaining to the bulb, which is linked as a load, is shown on an LCD panel. An electrical display module that includes multiple applications is the Liquid Crystal Display (LCD). A 16x2 LCD display, which has two 16-pin controllers, is a relatively basic module that is used in many different products and circuits [19]. These modules outperform seven segment and other multi-segment LEDs, because they are less expensive, simpler to program, and allow for the display of distinctive characters and even imaginative animations (unlike seven segments). [8]The system's status is displayed on an LCD panel.

In this project, a Wi-Fi module (ESP32) is used to operate a variety of devices, such as sensors, Relay, power supplies for the ignition system, displays, and more. This new ESP32 is the replacement for the well-known ESP8266, which gained a lot of popularity due to its built-in Wi-Fi. [18]. In addition to Wi-Fi, the ESP32 offers Bluetooth and Bluetooth Low Energy. The ESP32 chip has a 240 MHz maximum operating frequency. [9] There are 34 digital pins in the ESP32 in total. These pins resemble the digital pins on an Arduino board, allowing you to add LED displays, OLED displays, sensors, buttons, buzzers, and other components [18]. Even though the ESP32 has 48 GPIO pins overall, only 25 of them are separated to the pin headers on the development board's two sides. The ESP32 offers a number of pins that support PWM capability, enabling you to produce signals that resemble analog signals with adjustable duty cycles. The ESP32 offers pins with input capture and pulse counter functionality. The capacitive touch sensor pins on the ESP32 may sense touch or proximity.[10] The ESP32 is compatible with a number of serial communication protocols, such as UART.

A web server is a piece of computer software and underlying hardware that processes HTTP or HTTPS requests.[15] For the remote display of voltage readings, current sensor readings, and power calculations with the cost or charges as per the program specified, we use the project factory server named domain platform. A cloud-based service that enables you to build anything for organizations of all kinds, from straightforward websites to intricate applications. [12]An IOT-based energy meter must have a web server application since it offers remote access to and control of the meter's data and functionality. Through a web-based interface, it enables users to keep an eye on energy use, establish thresholds, get alerts and regulate energy usage.

To find out the voltage across the load connected A transistor name BC547 is used. The voltage is measured across the transistor.

The operation statuses of BC547 are forward bias and reverse bias.[14] When the collector and emitter are coupled, the current can flow when the bias is in the forward position. When in the reverse bias state, it functions as a disconnect switch and prevents current from flowing. [20]

The Arduino project offers a cross-platform application called the integrated development environment (IDE). The Arduino Integrated Development Environment (IDE) is a free integrated toolset for configuring an Arduino processor. [15] The coding is finished in embedded C. The Arduino IDE software includes a text editor for writing code, many menus, a toolbar with buttons for frequently used activities, and a text console. In order to upload programs, it establishes a connection with the Arduino hardware and communicates with it. [16]The pins are specified in the void setup() method. The void loop () contains the routines to execute various device actions (ON/OFF). These are managed and monitored by the server.





COMPONENTS	MODEL OR SPECIFICATION	MODEL PICTURE
Wi-fi-Module	ESP32 Microcontroller board (Arduino Ide)	
Transistor	BC547	
Current Sensor	ZHT102 5A Single Phase	
LCD	16*2	

Fig 3.1 List of components.

Algorithm:

- Step-1: Connect the regulated power supply
- Step-2: Activating the circuit
- Step-3: Measuring the current consume
- Step-4: Measuring the voltage across the load
- Step-5: Calculating the Power Consumed, total amount
- Step-6: If the power consumed is greater than the Threshold
- Step-7: Buzzer on
- Step-8: Start

Flow chart:

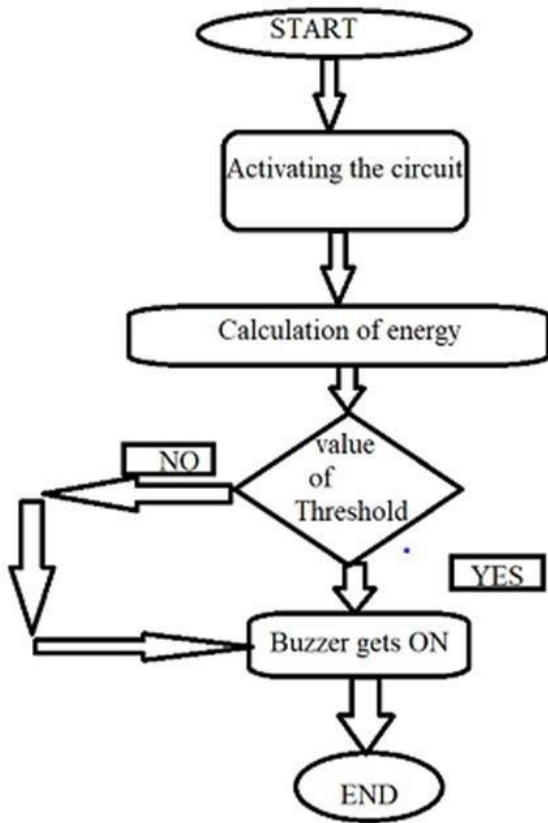

Fig 3.2 Flow chart

Working Algorithm:

Before starting the project, research was done on the different modules and the specific microcontroller version that would be used. Each pin of the module was connected in accordance with the circuit design. The code was created in the IDE program and then downloaded to the microcontroller, according to the various system components.

The circuit is activated by applying the regulated power supply to the circuit, load is connected at the output. The current and voltage consumed by the load is sensed by the transistor and current sensor are sent to the controller in which power consumed and the amount is calculated and these parameters are displayed in the LCD screen. If the current consumption is greater that the threshold value the buzzers is on. The values of current, voltage, power consumed, amount is also displayed on the project factor server which is created on the web .Using this webserver the smart energy meter is connected to the IOT as the user can check the information from anywhere in the world.

4. RESULTS AND DISCUSSIONS:

The parameters are sensed and calculated and are displayed in the LCD and web server as following and the LCD displays the following messages:



Fig 4.1: LCD display after activating the circuit



Fig 4.2: LCD parameters display before connecting the load

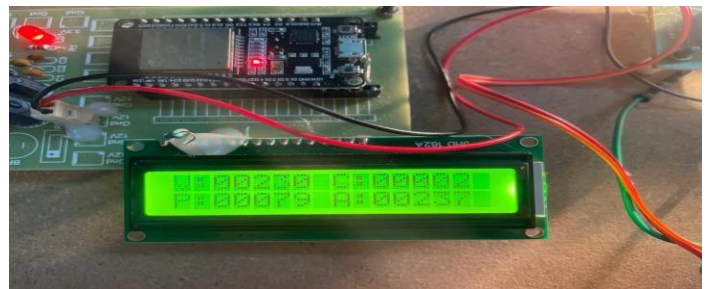

Fig 4.3: Parameters display after connecting the load

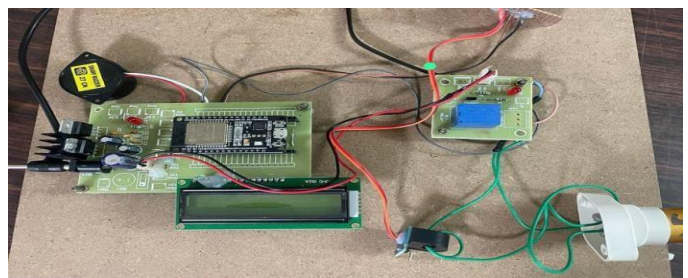

Fig 4.4: Circuit before giving regulated power supply

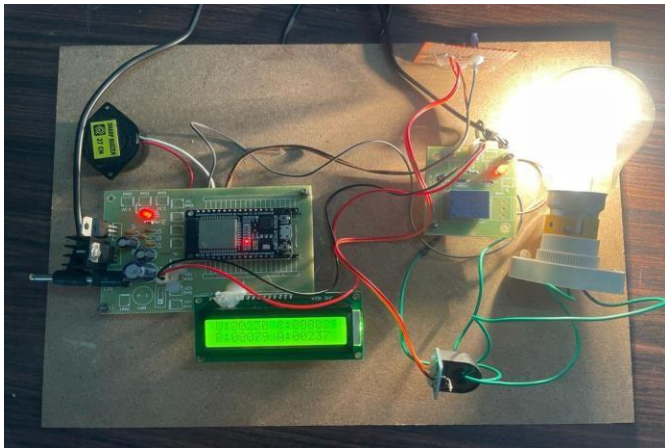

Fig 4.5: Circuit after activation power supply

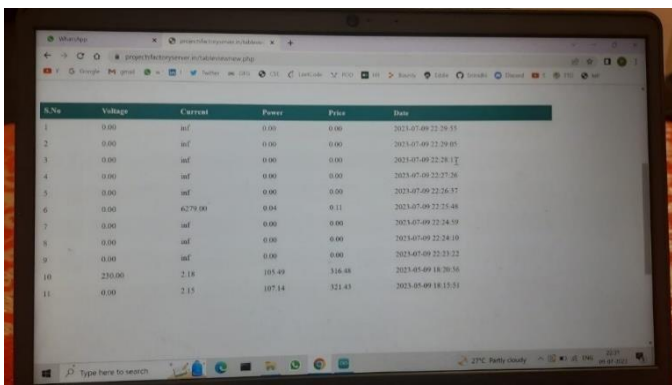

Fig 4.6: Project Factory Server Display

5. CONCLUSION:

An energy meter consisting a WI-FI module ,current sensor, and connected to a IOT server is named as Smart energy meter Through a IOT server ,the network spontaneously check the energy meter, provides home automation, and handles power management. The suggested system uses less energy and eliminates physical labor. To centralize the office, we can directly obtain monthly energy usage from a distant site. By doing this, we lessen the labor-intensive process of manually visiting each residence to record the meter readings, which was previously required. The IOT network is the main objective of the project. Due to which the power consumed can be accessed from anywhere in the world this project can be further developed by adding other options such as prepayment, energy theft, and much more, At the end of this project we draw the inference that the consumption of power is calculated and uploaded to the website using Internet Of Things.

6. ADVANTAGES:

- There will be less wastage of energy as the consumer can set the monthly billing budget.
- Reduction of manpower as there is no need of electricity department people to visit the household to check the consumption of power.

The cost of this energy meter is not more expensive as the devices used are low in cost and there is need to replace the energy meters.

7. APPLICATIONS:

- Smart light and temperature
- Smart meters and sensors can be used to manage energy effectively
- Energy storage
- Optimization of power production processes

8. REFERENCES:

- [1] Somchai Thepphaeng Chaiyod Pirak. Design and Implementation of Wireless Sensor Network and Protocol for Smart Energy Meter. 2011 International Conference on Circuits, System and Simulation IPCSIT vol.7 (2011) © (2011) IACSIT Press, Singapore.
- [2] Maha Aboelmaged, Yasmeen Abdelghani, Mohamed A. Abd El Ghany “Wireless IoT based Metering System for Energy Efficient Smart Cities”, International Journal of Scientific and Research Publications, Volume 5, Issue 3, March 2017, ISSN 2250-3153
- [3] Birendrakumar Sahani, Tejashree Ravi, Akibjaved Tamboli, Ranjit Pisal “IoT Based Smart Energy Meter”. International Research Journal of Engineering and technology volume:04 Issue:04(April-2017).
- [4] Yuksekkaya, B.; Kayalar, A.A.; Tosun, M.B.; Ozcan, M.K.; Alkar, A.Z.A GSM, Internet and Speech Controlled Wireless Interactive Home Automation System. IEEE Trans. Consum. Electron. 2006, 52, 837– 843
- [5] Himanshu kpatel “arduino based smart energy meter” 2nd Int'l Conf. on Electrical Engineering and Information & Communication Technology (ICEEICT) 2018.
- [6] “Bibek Kanti Barman, et.al” proposed paper “smart meter using IoT” department of international electronics and electrical engineering (IEEE) 2017.
- [7] Garrab.A, Bouallegue.A, Ben Abdullah, A new AMR approach for energy savings in Smart Grids using Smart meter and partial power line communication”, IEEE First International Conference on ICICS, vol 3, pp. March 2012.
- [8] Landi,c.: Dipt. Di Ing.dell”Inf, SecondaUniv di Napoli,Aversa,Italy; Merola p.”ARM-based energy management system using smart meter and Web server”,IEEE instrumentation and measurement technology conference binjing, pp.1-5 may 2011.
- [9] B. S. Koay, S. S. Cheah, Y. H. Sng, P. H. Chong, P. Shum, Y. C. Tong, X. Y. Wang, Y. X. Zuo and H. W. Kuek, "Design and implementation of Bluetooth energy meter", IEEE Proceedings of the 4th International Joint Conference of the ICICS, vol. 3, pp. 1474-1477, Dec,2003.
- [10]N. Fathima, A. Ahammed, R. Banu, B.D. Parameshachari, and N.M. Naik, “Optimized neighbor discovery in Internet of Things (IoT),” In Proc. of International Conference on

Electrical, Electronics, Communication, Computer, and Optimization Techniques (ICEECCOT), pp. 1-5, 2017.

[1] Chih-Yung Chang, Chin-Hwa Kuo, Jian-Cheng Chen and Tzu-Chia Wang Design and Implementation of an IoT Access Point for Smart Home. Applied Science; ISSN 2076-3417.

www.mdpi.com/journal/applsci

[2] Su, J.H.; Lee, C.S.; Wu, W.C. The Design and Implementation of a Low-Cost and Programmable Home Automation Module. IEEE Trans. Consum. Electron. 2006, 52, 1239–1244.

[3] Lucia, L.B.; Toscano, E. Coexistence Issues of Multiple Co- Located IEEE 802.15.4/ZigBee Networks Running on Adjacent Radio Channels in Industrial Environments. IEEE Trans. Ind. Inform. 2009, 5, 157–167.

[4] Shuaib, K.; Boulmalf, M.; Sallai, F.; Lakas, A. CoExistence of ZigBee and WLAN, a Performance Study. In Proceedings of the 2006 IFIP International Conference on Wireless and Optical Communications Networks, Bangalore, CA, USA, 11–13 April 2006; pp. 1–6.

[5] Sneha Chaudhari, Purvang Rathod, Ashfaque Shaikh “Smart Energy Meter Using Arduino and GSM”, International Conference on Trends in Electronics and Information. [2017]

[6] “Md.MasudurRahman, Noor-E-Jannat, Mond Ohidul. Lslam, Md. Serazus Salakin “Arduino and GSM Based Smart Energy Meter For advance Metering And Billing System” International conference on electrical engineering and communication technology[2015].

[7] Rohit Bhilare, Shital Mali “IoT based smart home with real time E-metering” International Conference on home automation for energy saving[2015].

[8] Anitha.k ,prathik, “Smart Energy Meter surveillance Using IoT” ,Institute of Electrical and Electronics Engineers(IEEE), 2019.

[9] Devadhanishini, et.al” “Smart Power Monitoring Using IoT” 5th International Conference on Advanced Computing & Communication Systems (ICACCS) 2019.

Mohammad Hossein Yaghmaee Design and Implementation of an Internet of Things Based Smart Energy Metering” 6th IEEE International Conference on Smart Energy Grid Engineering 2018.

